

DATE	REV	DESCRIPTION	DATE	APPROVED
-	NC	INITIAL RELEASE		
-	OT	REVISE FROM 48X48 STD. GATE	07/27/12	

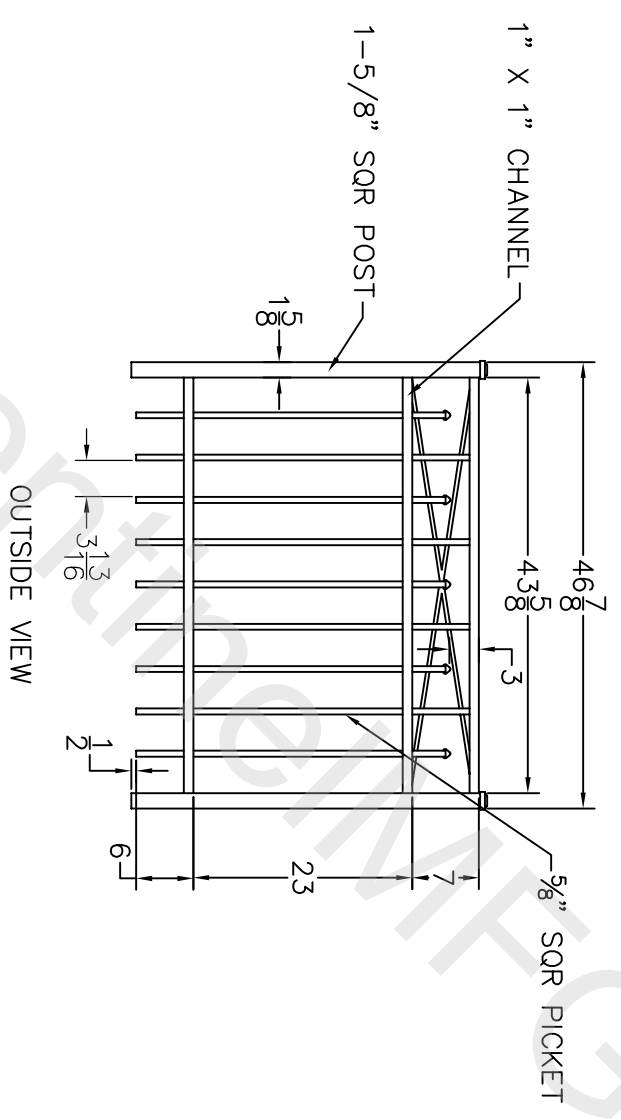

- NOTES:
1. ALL DIMENSIONS IN INCHES.
 2. INSTALL POSTS PER STANDARD CONSTRUCTION PRACTICES

SENTINEL MFG.
 1527 NC HWY 711
 LUMBERTON, NC 28360
 (910) 735-1351

DRAWING:
 OUTBACK GATE-
 36"HT X 48" WD

SIZE	DWG NO.	DATE	SHEET	REV
D	OU-36HX48W	01-31-12	1 OF 1	NC

© 2005. This drawing may not be altered or reproduced without the permission of SENTINEL MFG.